

SURFACE MOUNT
GLASS PASSIVATED SILICON RECTIFIER
VOLTAGE RANGE 50 to 1000 Volts CURRENT 1.0 Ampere

FEATURES

- * Glass passivated device
- * Ideal for surface mounted applications
- * Low leakage current
- * Metallurgically bonded construction
- * Mounting position: Any
- * Weight: 0.015 gram

MECHANICAL DATA

- * Epoxy : Device has UL flammability classification 94V-0

MAXIMUM RATINGS AND ELECTRICAL CHARACTERISTICS

Ratings at 25 °C ambient temperature unless otherwise specified.
 Single phase, half wave, 60 Hz, resistive or inductive load.
 For capacitive load, derate current by 20%.

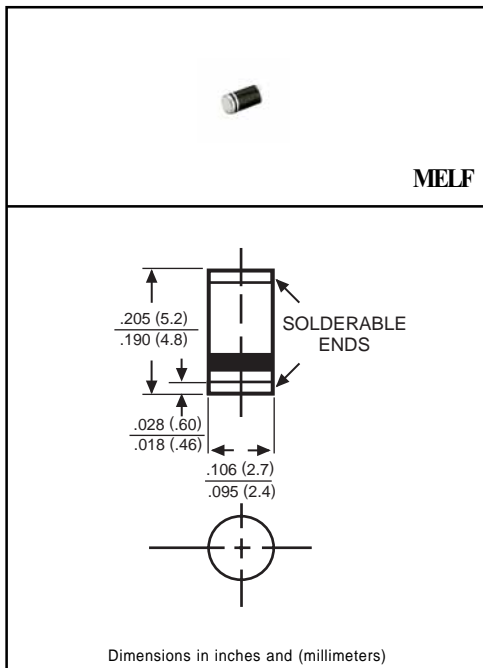

MAXIMUM RATINGS (At TA = 25°C unless otherwise noted)

RATINGS	SYMBOL	SM4001	SM4002	SM4003	SM4004	SM4005	SM4006	SM4007	UNITS
Maximum Recurrent Peak Reverse Voltage	VRRM	50	100	200	400	600	800	1000	Volts
Maximum RMS Voltage	VRMS	35	70	140	280	420	560	700	Volts
Maximum DC Blocking Voltage	VDC	50	100	200	400	600	800	1000	Volts
Maximum Average Forward Rectified Current TA = 75°C	IO	1.0							Amps
Peak Forward Surge Current IFM(surge): 8.3 ms single half sine-wave superimposed on rated load (JEDEC method)	IFSM	30							Amps
Maximum Thermal Resistance	(Note 2) RθJL	20							°C/W
	(Note 3) RθJA	50							°C/W
Typical Junction Capacitance (Note 1)	CJ	15							pF
Operating and Storage Temperature Range	TJ, TSTG	-65 to + 175							°C

ELECTRICAL CHARACTERISTICS (At TA = 25°C unless otherwise noted)

CHARACTERISTICS	SYMBOL	SM4001	SM4002	SM4003	SM4004	SM4005	SM4006	SM4007	UNITS
Maximum Forward Voltage at 1.0A DC	VF	1.1							Volts
Maximum Full Load Reverse Current, Full cycle Average at TA=75 °C	IR	30							uAmps
Maximum DC Average Reverse Current at @TA = 25°C		5.0							uAmps
Rated DC Blocking Voltage @TA = 125°C		50							uAmps

- NOTES : 1. Measured at 1.0 MHz and applied average voltage of 4.0VDC
 2. Thermal resistance junction to terminal 6.0mm² copper pads to each terminal.
 3. Thermal resistance junction to ambient, 6.0mm² copper pads to each terminal.

RATING AND CHARACTERISTIC CURVES (SM4001 THRU SM4007)

FIG. 1 - TYPICAL FORWARD CURRENT DERATING CURVE

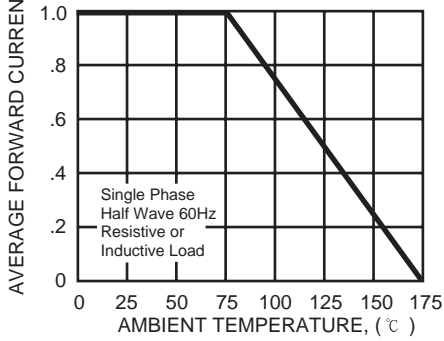

FIG. 2 - MAXIMUM NON-REPETITIVE FORWARD SURGE CURRENT

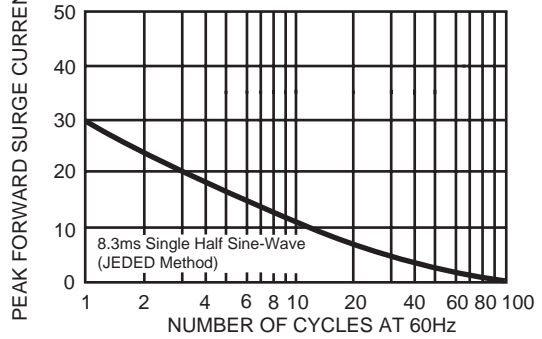

FIG. 3 - TYPICAL INSTANTANEOUS FORWARD CHARACTERISTICS

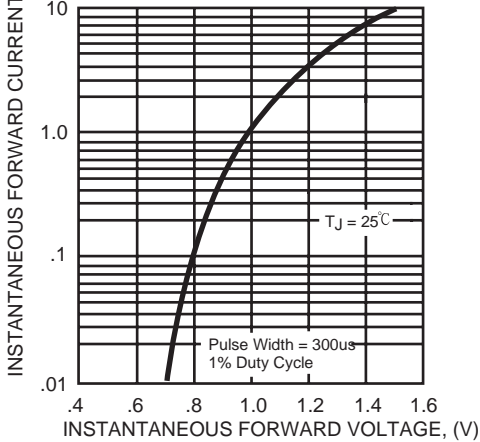

FIG. 4 - TYPICAL REVERSE CHARACTERISTICS

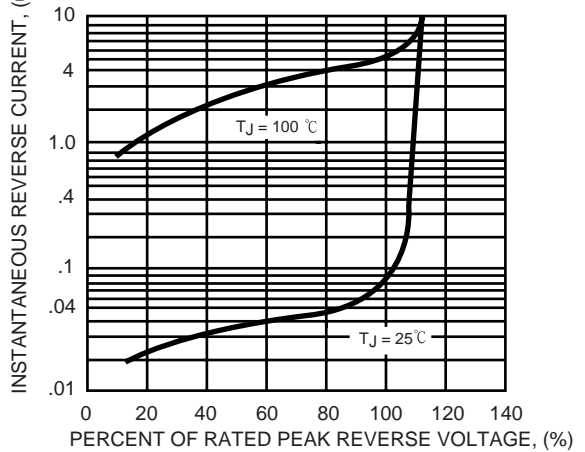
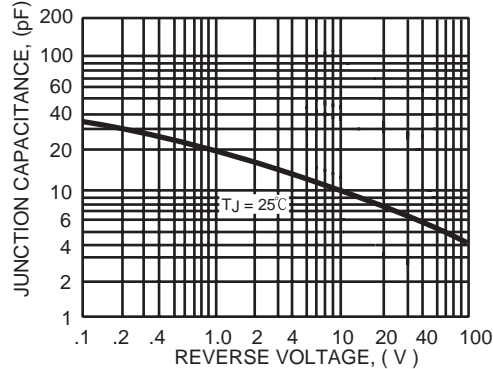
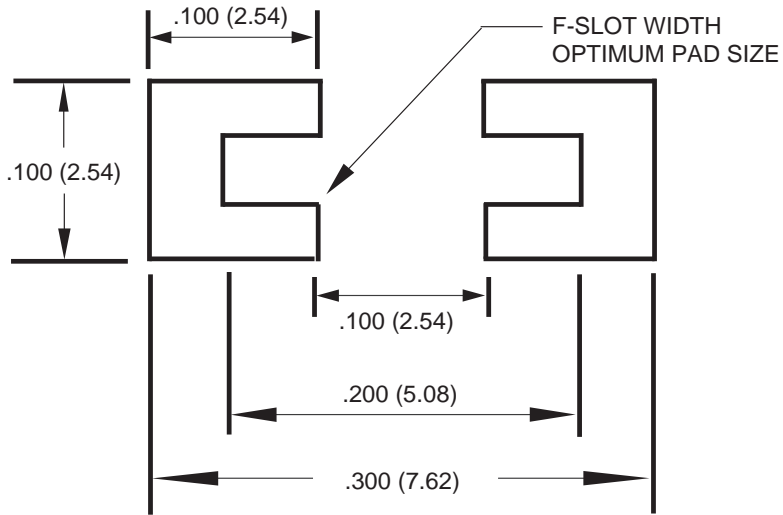

FIG. 5 - TYPICAL JUNCTION CAPACITANCE



Mounting Pad Layout



Dimensions in inches and (millimeters)