

SURFACE MOUNT SCHOTTKY BARRIER RECTIFIER

VOLTAGE RANGE 20 to 40 Volts CURRENT 3.0 Amperes

FEATURES

- * Ideal for surface mounted applications
- * Low leakage current
- * Metallurgically bonded construction
- * Mounting position: Any
- * Weight: 0.24 gram

MECHANICAL DATA

- * Epoxy: Device has UL flammability classification 94V-O

DO-214AB

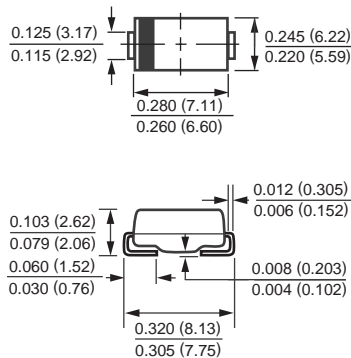

Dimensions in inches and (millimeters)

MAXIMUM RATINGS AND ELECTRICAL CHARACTERISTICS

Ratings at 25 °C ambient temperature unless otherwise specified.
 Single phase, half wave, 60 Hz, resistive or inductive load.
 For capacitive load, derate current by 20%.

MAXIMUM RATINGS (At TA = 25°C unless otherwise noted)

RATINGS	SYMBOL	FM5820	FM5821	FM5822	UNITS
Maximum Recurrent Peak Reverse Voltage	VRRM	20	30	40	Volts
Maximum RMS Voltage	VRMS	14	21	28	Volts
Maximum DC Blocking Voltage	VDC	20	30	40	Volts
Maximum Average Forward Rectified Current at Derating Lead Temperature	IO	3.0			Amps
Peak Forward Surge Current 8.3 ms single half sine-wave superimposed on rated load (JEDEC method)	IFSM	80			Amps
Typical Thermal Resistance (Note 1)	RθJA	25			°C/W
Typical Junction Capacitance (Note 2)	CJ	200			pF
Operating Temperature Range	TJ	-55 to + 125		-55 to + 150	°C
Storage Temperature Range	TSTG	-55 to + 150			°C

ELECTRICAL CHARACTERISTICS (At TA = 25°C unless otherwise noted)

CHARACTERISTICS	SYMBOL	FM5820	FM5821	FM5822	UNITS
Maximum Instantaneous Forward Voltage at 3.0A DC	VF	.475	.5	.525	Volts
Maximum Average Reverse Current	IR	@ TA = 25°C			mAmps
at Rated DC Blocking Voltage		@ TA = 100°C			mAmps

NOTES : 1. Thermal Resistance (Junction to Ambient).
 2. Measured at 1 MHz and applied reverse voltage of 4.0 volts.

RATING AND CHARACTERISTIC CURVES (FM5820 THRU FM5822)

FIG. 1 - TYPICAL FORWARD CURRENT DERATING CURVE

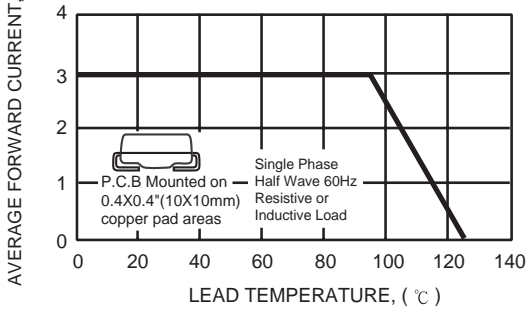

FIG. 2 - TYPICAL REVERSE CHARACTERISTICS

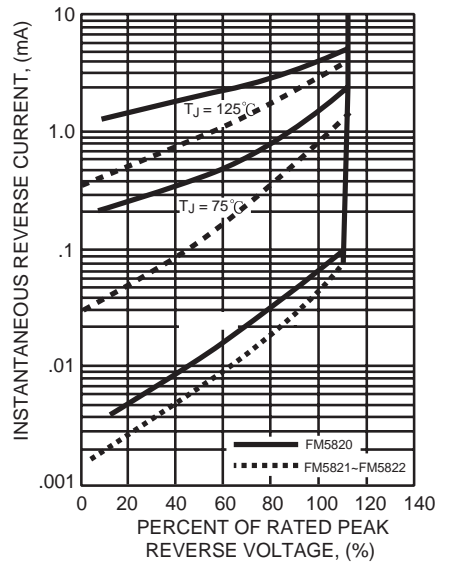

FIG. 3 - MAXIMUM NON-REPETITIVE FORWARD SURGE CURRENT

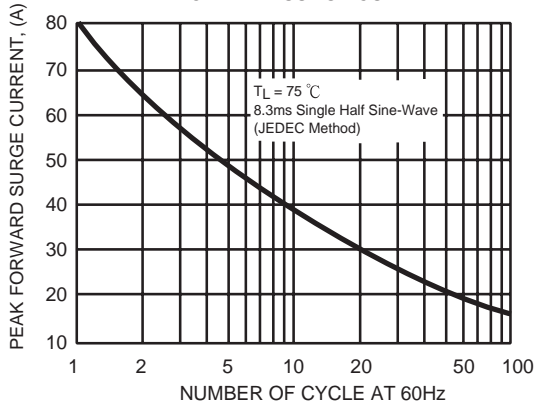

FIG. 5 - TYPICAL INSTANTANEOUS FORWARD CHARACTERISTICS

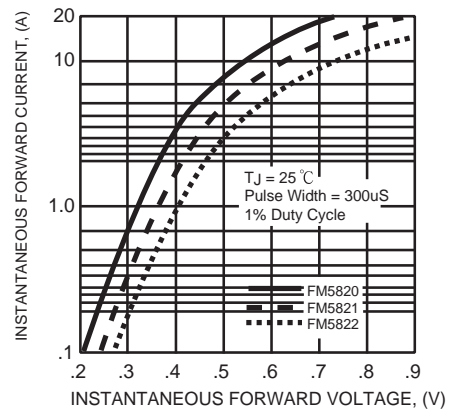
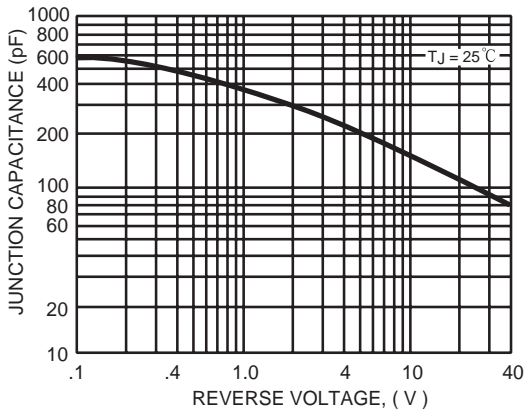
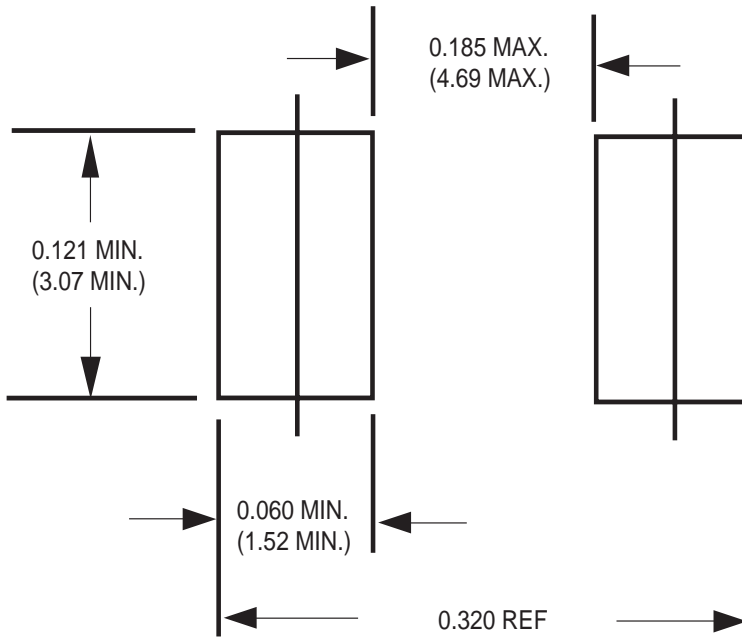

FIG. 4 - TYPICAL JUNCTION CAPACITANCE



Mounting Pad Layout



Dimensions in inches and (millimeters)