

SURFACE MOUNT SCHOTTKY BARRIER RECTIFIER

VOLTAGE RANGE 20 to 40 Volts CURRENT 1.0 Ampere

FEATURES

- * Ideal for surface mounted applications
- * Low leakage current
- * Metallurgically bonded construction
- * Mounting position: Any
- * Weight: 0.057 gram

MECHANICAL DATA

- * Epoxy: Device has UL flammability classification 94V-O

MAXIMUM RATINGS AND ELECTRICAL CHARACTERISTICS

Ratings at 25 °C ambient temperature unless otherwise specified.
 Single phase, half wave, 60 Hz, resistive or inductive load.
 For capacitive load, derate current by 20%.



DO-214AC

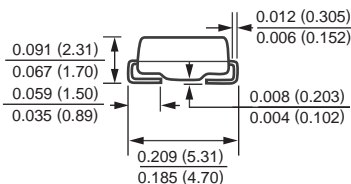
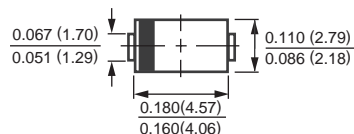

Dimensions in inches and (millimeters)

MAXIMUM RATINGS (At TA = 25°C unless otherwise noted)

RATINGS	SYMBOL	FM5817	FM5818	FM5819	UNITS
Maximum Recurrent Peak Reverse Voltage	VRRM	20	30	40	Volts
Maximum RMS Voltage	VRMS	14	21	28	Volts
Maximum DC Blocking Voltage	Vbc	20	30	40	Volts
Maximum Average Forward Rectified Current at TA= 90°C	IO	1.0			Amps
Peak Forward Surge Current 8.3 ms single half sine-wave superimposed on rated load (JEDEC method)	IFSM	25			Amps
Typical Thermal Resistance (Note 1)	RθJA	80			°C/W
Typical Junction Capacitance (Note 2)	CJ	110			pF
Storage and Operating Temperature Range	TJ, TSTG	-65 to + 125			°C

ELECTRICAL CHARACTERISTICS (At TA = 25°C unless otherwise noted)

CHARACTERISTICS	SYMBOL	FM5817	FM5818	FM5819	UNITS
Maximum Forward Voltage at 1.0A DC	VF	.45	.55	.60	Volts
Maximum Forward Voltage at 3.1A DC	VF	.75	.875	.90	Volts
Maximum Average Reverse Current at Rated DC Blocking Voltage	IR	@ TA = 25°C			mAmps
		@ TA = 100°C			
		1.0			
		10			

NOTES : 1. Thermal Resistance (Junction to Ambient): Vertical PC Board Mounting, 0.5" (12.7mm) Lead Length.
 2. Measured at 1 MHz and applied reverse voltage of 4.0 volts.

RATING AND CHARACTERISTIC CURVES (FM5817 THRU FM5819)

FIG. 1 -- TYPICAL FORWARD CURRENT DERATING CURVE

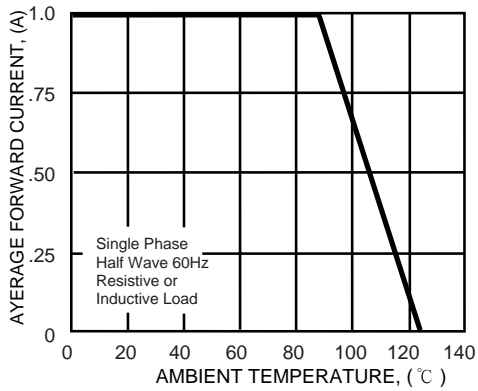

FIG. 2 - TYPICAL INSTANTANEOUS FORWARD CHARACTERISTICS

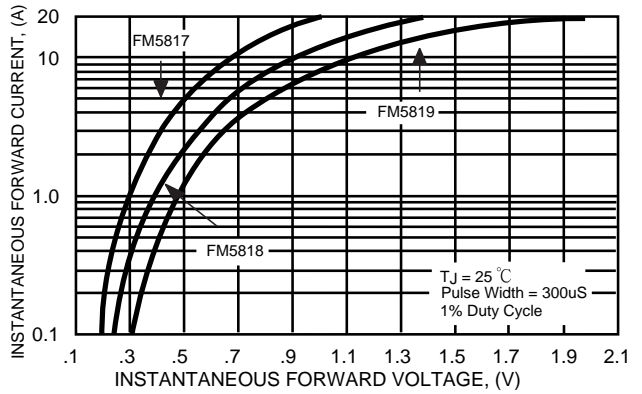

FIG. 3 - TYPICAL REVERSE CHARACTERISTICS

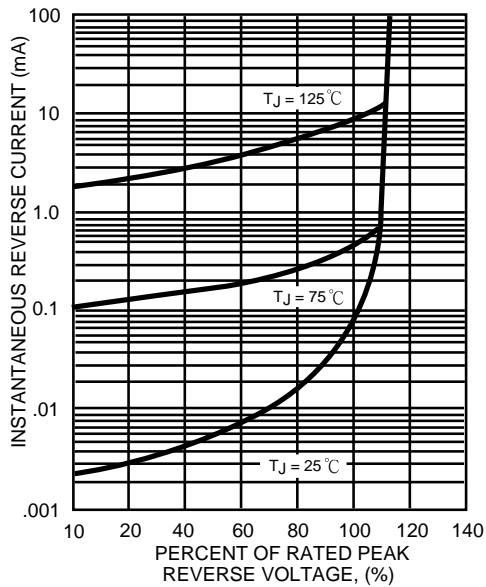

FIG. 4 - MAXIMUM NON-REPETITIVE FORWARD SURGE CURRENT

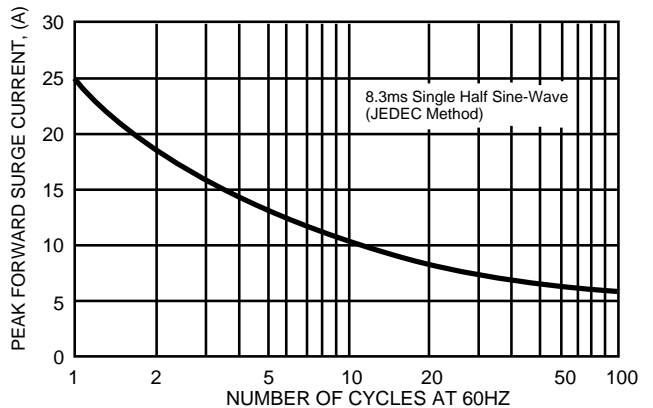
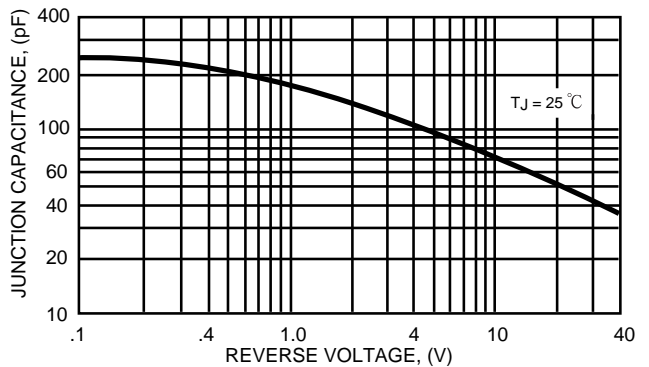
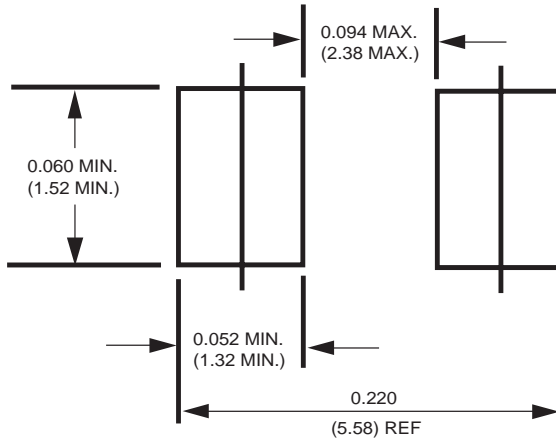

FIG. 5 - TYPICAL JUNCTION CAPACITANCE



Mounting Pad Layout



Dimensions in inches and (millimeters)