

**SURFACE MOUNT GLASS PASSIVATED  
FAST RECOVERY SILICON RECTIFIER**  
VOLTAGE RANGE 50 to 600 Volts CURRENT 1.0 Ampere

**FEATURES**

- \* Glass passivated device
- \* Ideal for surface mounted applications
- \* Low leakage current
- \* Metallurgically bonded construction
- \* Mounting position: Any
- \* Weight: 0.057 gram

**MECHANICAL DATA**

- \* Epoxy : Device has UL flammability classification 94V-0

**DO-214AC**

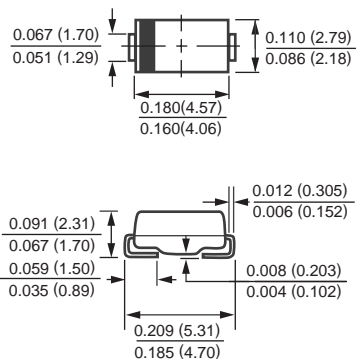

Dimensions in inches and (millimeters)

**MAXIMUM RATINGS AND ELECTRICAL CHARACTERISTICS**

Ratings at 25 °C ambient temperature unless otherwise specified.  
Single phase, half wave, 60 Hz, resistive or inductive load.  
For capacitive load, derate current by 20%.

**MAXIMUM RATINGS** (At TA = 25°C unless otherwise noted)

RATINGS	SYMBOL	FM4933	FM4934	FM4935	FM4936	FM4937	UNITS
Maximum Recurrent Peak Reverse Voltage	VRRM	50	100	200	400	600	Volts
Maximum RMS Voltage	VRMS	35	70	140	280	420	Volts
Maximum DC Blocking Voltage	VDC	50	100	200	400	600	Volts
Maximum Average Forward Rectified Current at TA = 55°C	IO	1.0					Amps
Peak Forward Surge Current IFM (surge): 8.3 ms single half sine-wave superimposed on rated load (JEDEC method)	IFSM	30					Amps
Maximum Thermal Resistance	(Note 2) RθJL	30					°C/W
	(Note 3) RθJA	70					°C/W
Typical Junction Capacitance (Note 1)	CJ	15					pF
Operating and Storage Temperature Range	TJ, TSTG	-65 to + 175					°C

**ELECTRICAL CHARACTERISTICS** (At TA = 25°C unless otherwise noted)

CHARACTERISTICS	SYMBOL	FM4933	FM4934	FM4935	FM4936	FM4937	UNITS
Maximum Forward Voltage at 1.0A DC	VF	1.2					Volts
Maximum Full Load Reverse Current, Full cycle Average at TA = 55°C	IR	50					uAmps
Maximum Average Reverse Current at @TA = 25°C		5.0					uAmps
Rated DC Blocking Voltage @TA = 125°C		100					uAmps
Maximum Reverse Recovery Time (Note 4)	trr	200					nSec

- NOTES : 1. Measured at 1.0 MHz and applied average voltage of 4.0VDC  
2. Thermal resistance junction to terminal 6.0mm<sup>2</sup> copper pads to each terminal.  
3. Thermal resistance junction to ambient, 6.0mm<sup>2</sup> copper pads to each terminal.  
4. Test Conditions: IF = 1.0A, VR = 30V.

# RATING AND CHARACTERISTIC CURVES ( FM4933 THRU FM4937 )

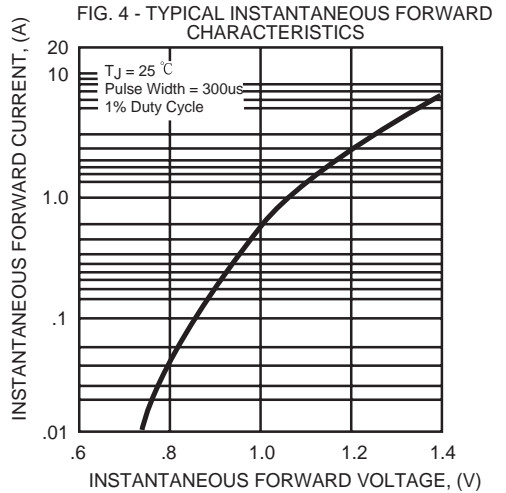
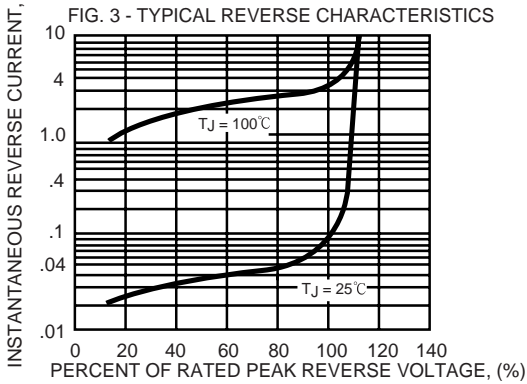
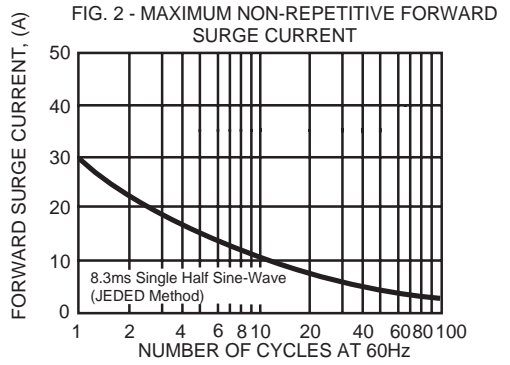
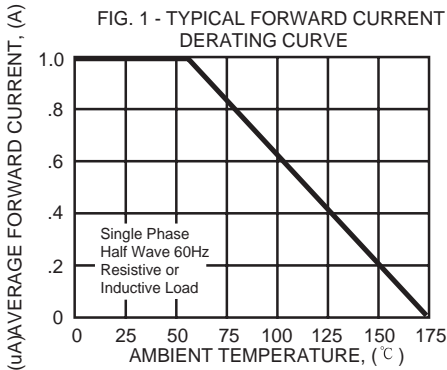

**FIG. 5 - TEST CIRCUIT DIAGRAM AND REVERSE RECOVERY TIME CHARACTERISTIC**

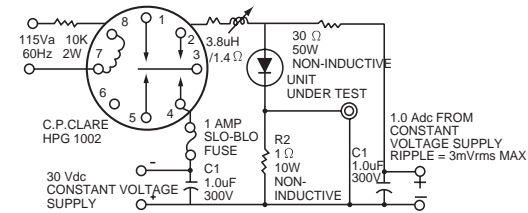

MINIMIZE ALL LEAD LENGTHS  
 A-TEKTRONIX 545A, K PLUG IN PRE AMP P6000 PROBE OR EQUIVALENT  
 R1-ADJUSTED FOR 1.4E1 BETWEEN POINT 2 OF RELAY AND RECTIFIER INDUCTIVE = 3.8uH  
 R2-TEN-1W 10 Ohm % CARBON CORE IN PARALLEL  
 $T_A = 25 \pm 10^\circ C$  FOR RECTIFIER

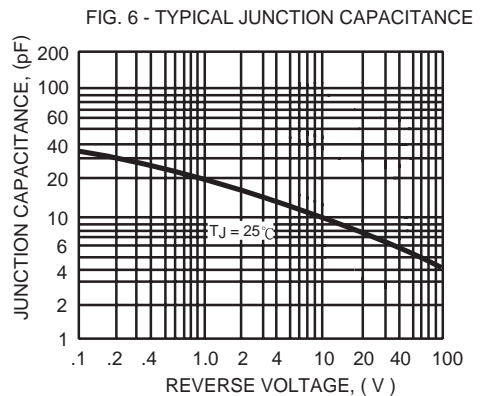
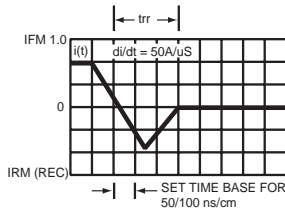

## Mounting Pad Layout

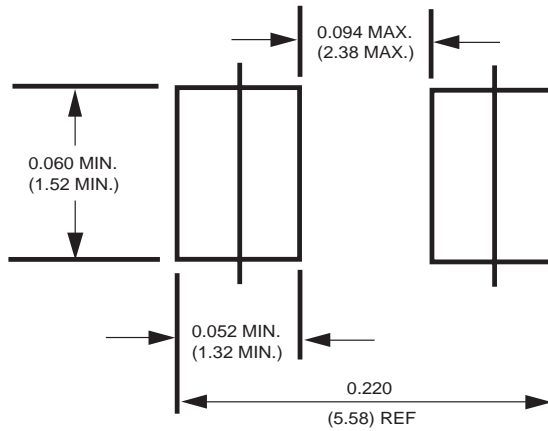

Dimensions in inches and (millimeters)